







**ORCHARD PRUNER ORT WITH DISCS**

Standard machine:



FRAME	SAFETY	HYDRAULIC KIT
<ul style="list-style-type: none"> <li>- Proportional distributor 4+1</li> <li>- Hydraulic lifting 145cm</li> <li>- Hydraulic tilting of the first arm</li> <li>- Hydraulic tilting of the cutting bar</li> <li>- Hydraulic translation on the cutting bar 60 cm</li> <li>- Disc bars Ø 60cm</li> </ul>	<ul style="list-style-type: none"> <li>- Hydraulic motors complete with anti-cavitation valve and pressure relief valve</li> <li>- Hydraulic stand for storage</li> </ul>	<ul style="list-style-type: none"> <li>- Hydraulic kit with 80 Lit/min pump, 90L oil tank, gearbox, oil cooler and cardan joint</li> <li>- Socket 12V</li> </ul>

CODE	MODEL	G cm	 Ø cm	 n.	 Ø cm	 kg	 kg	€
6ORT105AP	<b>ORT 5</b>	250	15	5	60	4000	585	<b>30.950,00</b>
6ORT106AP	<b>ORT 6</b>	300	15	6	60	4000	600	<b>31.950,00</b>

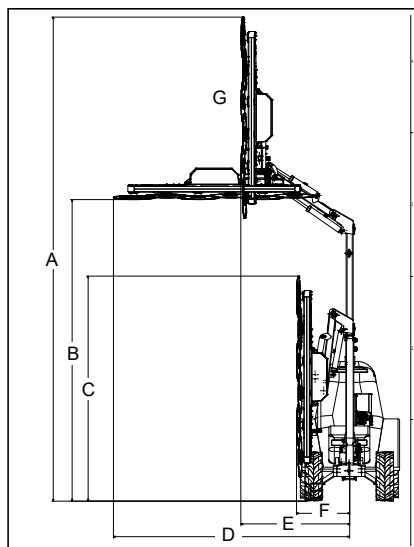
**NB PRICE DOES NOT INCLUDE COUPLING FRAME FOR TRACTOR**



MOD.	A cm	B cm	C cm	D cm	E cm	F cm
ORT 5	660	440	280	295	160	80
ORT 6	710	440	330	345	160	80

ACCESSORIES	CODE	DESCRIPTION	€
	60319	Independent hydraulic power unit with gearbox, 80 L pump, 90 L oil tank, oil cooler and cardan	<b>Included</b>
	470013	3-blades green pruning kit to be mounted in place of the 60 cm disc	<b>each 185,00</b>
	10891	3 point coupling CAT 1 and 2 for tractors with front lift	<b>905,00</b>